



**ILUMI**  
A marca do lar brasileiro

# O MIX+ COMPLETO DO MERCADO



RUA FÁBIO FRANZO, 230/240 - DISTRITO INDUSTRIAL PAULO KINOCK - LEME/SP - CEP: 13612-390 - TEL./FAX: (19) 3572-2299  
www.ilumi.com.br - ilumi@ilumi.com.br



A PARTIR DE AGORA

# 19

NOVE



Editado em: 06/03/2024 - nº 0323  
www.ilumi.com.br

ACESSE O SITE





# índice

<b>Lançamentos</b>	.....03
 <b>monobloco</b>	<i>passo a passo</i> ...04
 <b>itec</b>	<i>itec</i> .....05
 <b>i9</b>	<i>conjuntos</i> .....06
	<i>placas</i> .....06
	<i>módulos</i> .....07
 <b>Vivaz</b>	<i>conjuntos</i> .....08
	<i>placas</i> .....08 e 09
	<i>módulos</i> .....10 e 11
 <b>slim</b>	<i>conjuntos</i> .....12
	<i>placas</i> .....13
	<i>módulos</i> .....14
	<i>retangulares</i> .....14
	<i>slim box</i> .....15
	<i>slim móveis</i> .....15
 <b>lev</b>	<i>conjuntos</i> .....16
	<i>placas</i> .....16 e 17
 <b>safira</b>	<i>conjuntos</i> .....18
	<i>placas</i> .....19
 <b>stylus</b>	<i>conjuntos</i> ...20 e 21
	<i>conjunto sem placa</i> .....22
	<i>placas</i> .....23
 <b>pratika</b>	<i>conjuntos</i> .....24
	<i>placas</i> .....25
 <b>sobrepor</b>	<i>box</i> .....26
	<i>econômica</i> .....27
	<i>retangular</i> .....27
 <b>pinos &amp; adaptadores</b>	.....28 e 29
 <b>canaletas</b>	.....30 e 31
 <b>caixas &amp; quadros</b>	.....32 e 33
 <b>iluminação</b>	.....34 e 35
 <b>eletrônica</b>	.....36 e 37
 <b>flex</b>	.....39 a 41
 <b>marketing</b>	<i>PDV</i> .....42 a 43
	<i>Ilumi Faz+</i> .....44
	<i>ISO e ESG</i> .....45
	<i>Site e Redes Sociais</i> ...46
	<i>Anotações</i> .....47



**A melhor telha de PVC do mercado brasileiro**

Telha Colonial



**SEGURANÇA**

**CONFORTO**



**ECONOMIA**



**+ economia de 15 a 25% para sua obra.**

**contato:**  
(71) 3648-1974  
contato@itecbahia.com.br



# ÚLTIMOS LANÇAMENTOS





# monobloco (mb)

## passo a passo

Apenas  
parafusos

# 3

**PASSO A PASSO:**  
Soltar os 3 parafusos,  
cabear e apertar  
novamente.



Serve para  
Tomada Tripla e  
Tomada Dupla



Já vem  
jampeado

Muito +  
resistentes

Fabricadas  
em ABS

Rápido  
e Prático  
para instalar!

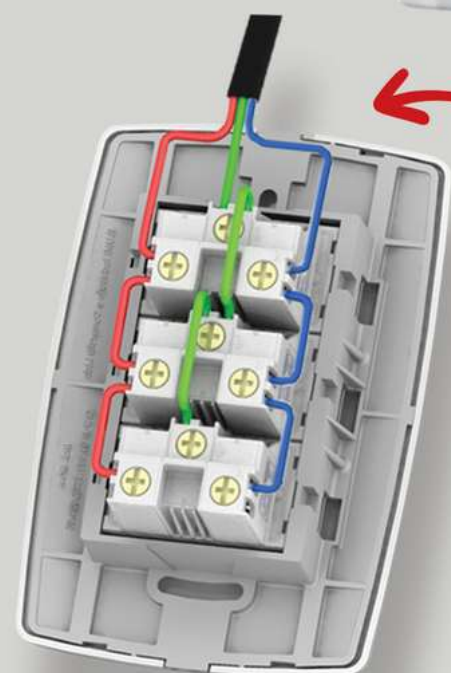

### Instalação antiga

Ligação de 3 Tomadas  
Tradicional

#### PASSO A PASSO:

Cortar 6 pedaços de cabo,  
soltar os 9 parafusos,  
cabear o cordão,  
fazer os 6 jampers,  
e apertar os parafusos  
novamente.

ACESSE O SITE



**itec**  
PRODUTOS EM PVC

Com alta tecnologia e diversidade as telhas de PVC Itec são o que há de melhor em qualidade e praticidade no segmento de coberturas

### lançamento telha romana PERTUTTI



cerâmica



marfim



verde



clareamento

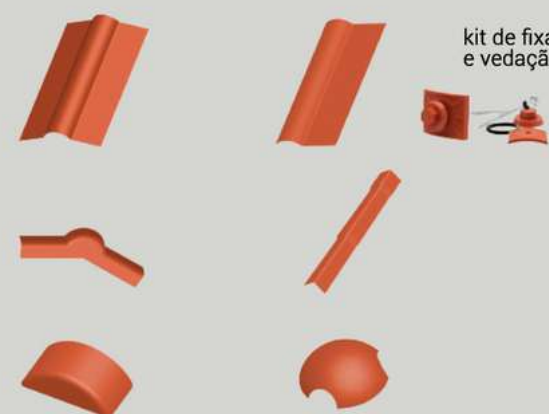

peças complementares



pinhão



branca

RESISTÊNCIA  
com charme

SEGURANÇA  
com requinte

ECONOMIA  
com conforto

MAIOR  
cobertura útil



# INTERRUPTORES E TOMADAS 4x2

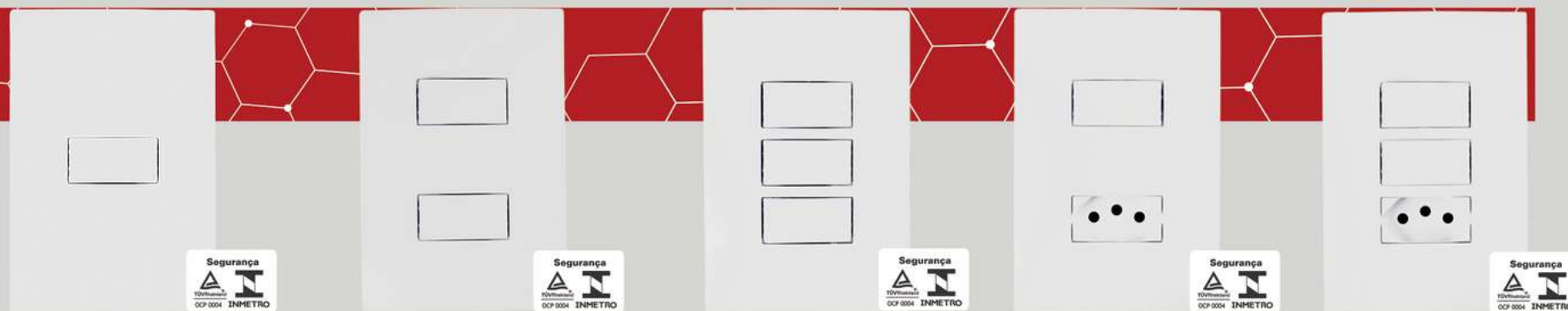

CJ. 1 Interruptor Simples 10A - Cód. 9417  
CJ. 1 Interruptor Paralelo 10A - Cód. 9422

CJ. 2 Interruptores Simples 10A - Cód. 9418  
CJ. 2 Interruptores Paralelos 10A - Cód. 9424

CJ. 3 Interruptores Simples 10A 250V~ Cód. 9419

CJ. 1 Interruptor Simples 10A + 1 Tomada 10A 250V~ Cód. 94200  
CJ. 1 Interruptor Simples 10A + Tomada 20A 250V~ Cód. 94201  
CJ. 1 Interruptor Paralelo 10A + Tomada 10A 250V~ Cód. 94280

CJ. 2 Interruptores Simples 10A + Tomada 10A 250V~ Cód. 94210  
CJ. 2 Interruptores Simples 10A + Tomada 20A 250V~ Cód. 94211



CJ. 1 Interruptor Simples 10A + 2 Tomadas 10A 250V~ Cód. 94203

CJ. 1 Tomada 250V~ 10A - Cód. 94140  
CJ. 2 Tomadas 10A 250V~ 20A - Cód. 94141

CJ. 2 Tomadas Monobloco 250V~ 10A - Cód. 94120  
CJ. 2 Tomadas Monobloco 250V~ 20A - Cód. 94121

CJ. 3 Tomadas Monobloco 250V~ 10A - Cód. 94123  
CJ. 3 Tomadas Monobloco 250V~ 20A - Cód. 94124



ACESSE O SITE

# PLACAS 4x2



Placa 4x2 cega Com suporte - Cód. 96050

Placa 4x2 - 1 módulo Com suporte - Cód. 96070

Placa 4x2 - 2 módulos separados Com suporte - Cód. 96080

Placa 4x2 - 3 módulos separados Com suporte Cód. 96100

proteção UV

# SUPOORTE PARA CONDULETE



CORPO PARA CAIXA DE CONDULETE SIMPLES Cód. 9801

CORPO PARA CAIXA DE CONDULETE DUPLO Cód. 9802

# PLACAS 4x4



Placa 4x4 - cega Com suporte - Cód. 97050

Placa 4x4 - 1+1 módulo Com suporte - Cód. 97060

Placa 4x4 - 2+2 módulos Com suporte - Cód. 97070

Placa 4x4 - 3+3 módulos Com suporte - Cód. 97090



LANÇAMENTO · LINHA INOVE · LANÇAMENTO · LINHA INOVE · LANÇAMENTO

# MÓDULOS

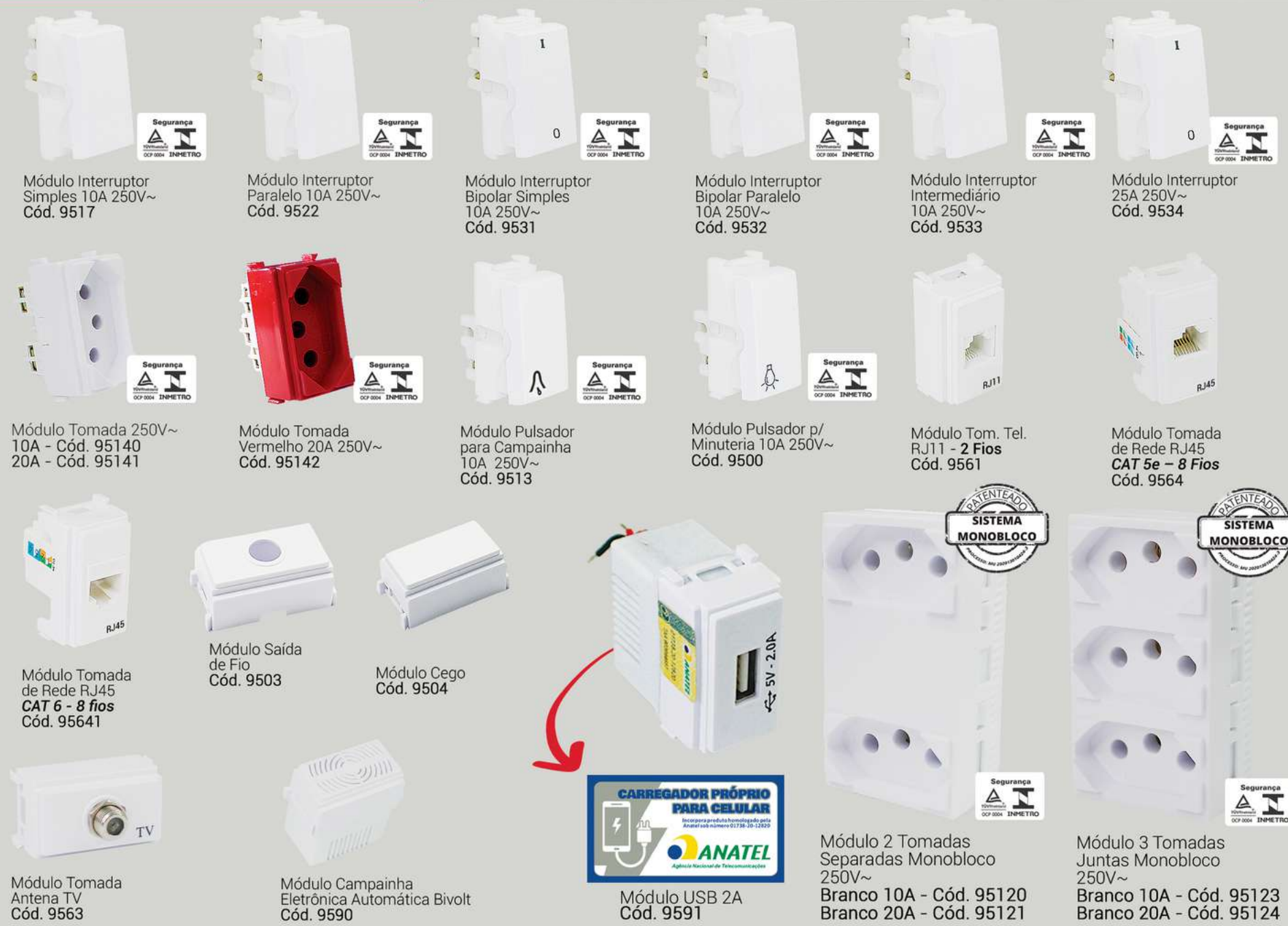

Módulo Interruptor Simples 10A 250V~ Cód. 9517

Módulo Interruptor Paralelo 10A 250V~ Cód. 9522

Módulo Interruptor Bipolar Simples 10A 250V~ Cód. 9531

Módulo Interruptor Bipolar Paralelo 10A 250V~ Cód. 9532

Módulo Interruptor Intermediário 10A 250V~ Cód. 9533

Módulo Interruptor 25A 250V~ Cód. 9534

Módulo Tomada 250V~ 10A - Cód. 95140  
Módulo Tomada 20A - Cód. 95141

Módulo Tomada Vermelho 20A 250V~ Cód. 95142

Módulo Pulsador para Campainha 10A 250V~ Cód. 9513

Módulo Pulsador p/ Minuteria 10A 250V~ Cód. 9500

Módulo Tom. Tel. RJ11 - 2 Fios Cód. 9561

Módulo Tomada de Rede RJ45 CAT 5e - 8 Fios Cód. 9564

Módulo Tomada de Rede RJ45 CAT 6 - 8 fios Cód. 95641

Módulo Saída de Fio Cód. 9503

Módulo Cego Cód. 9504

Módulo Tomada Antena TV Cód. 9563

Módulo Campainha Eletrônica Automática Bivolt Cód. 9590

Módulo USB 2A Cód. 9591

Módulo 2 Tomadas Separadas Monobloco 250V~ Branco 10A - Cód. 95120  
Módulo 2 Tomadas Separadas Monobloco 250V~ Branco 20A - Cód. 95121

Módulo 3 Tomadas Juntas Monobloco 250V~ Branco 10A - Cód. 95123  
Módulo 3 Tomadas Juntas Monobloco 250V~ Branco 20A - Cód. 95124



Módulo USB 2A Cód. 9591



# INTERRUPTORES E TOMADAS 4x2



ACESSE O SITE



CJ. 1 Interruptor Simples 10A - Cód. 7817

CJ.2 Interruptores Simples 10A - Cód. 7818  
CJ. Interruptores Simples 10A + interruptor paralelo 10A 250V~ Cód. 7823

CJ. 3 Interruptores Simples 10A 250V~ Cód. 7819

CJ. 1 Interruptor Simples + 1 Tomada 10A - Cód. 78200  
CJ. Interruptor Simples 10A + Tomada 20A 250V~ Cód. 78201

CJ. 2 Interruptores Simples 10A + Tomada 10A 250V~ Cód. 78210



CJ. 1 Interruptor Simples 10A + 2 Tomadas 10A 250V~ Cód. 78203

CJ. 1 Tomada 10A 250V~ + 1 Tomada USB 2A Cód. 781500

CJ. 1 Tomada 250V~ 10A - Cód. 78140  
20A - Cód. 78141

CJ. 2 Tomadas Monobloco 250V~ 10A - Cód. 78120  
20A - Cód. 78121

CJ. 3 Tomadas Monobloco 250V~ 10A - Cód. 78123  
20A - Cód. 78124



CJ. Campanha Eletrônica Automática Bivolt Cód. 7890

Foto ilustrativa com sugestão de montagem modular itens:  
Placa 4x2 - 3 módulos juntos com suporte Cód. 76100  
Módulo tomada 20A 250V~ Cód. 75141  
Módulo protetor MPT bivolt 10A Cód. 7593  
Módulo interruptor simples 10A 250V~ Cód. 7517

proteção UV

## SUPORTES



Suporte 4x2 Cód. 7601

Suporte 4x4 Cód. 7602

## PLACAS 4x2



Placa 4x2 cega Cód. 7605 Com suporte - Cód. 76050

Placa 4x2 - 1 módulo Cód. 7607 Com suporte - Cód. 76070

Placa 4x2 - 2 módulos separados Cód. 7608 Com suporte - Cód. 76080

Placa 4x2 - 3 módulos juntos Cód. 7610 Com suporte - Cód. 76100

resistente  
qualidade  
alto padrão  
DESIGN moderno

Vivaz



## PLACAS 4x4

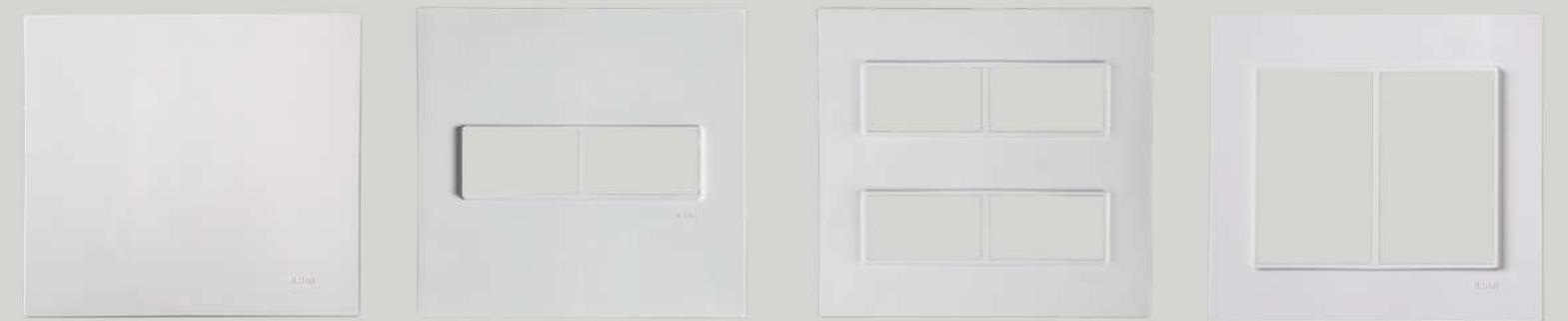

Placa 4x4 - cega Cód. 7705 Com suporte - Cód. 77050

Placa 4x4 - 1+1 módulo Cód. 7706 Com suporte - Cód. 77060

Placa 4x4 - 2+2 módulos Cód. 7707 Com suporte - Cód. 77070

Placa 4x4 - 3+3 módulos Cód. 7709 Com suporte - Cód. 77090

• LANÇAMENTO • VIVAZ PRETA • LANÇAMENTO • LANÇAMENTO • VIVAZ PRETA • LANÇAMENTO

## PLACAS 4x2



Placa 4x2 Preta - Cega Com Suporte - Cód. 76051

Placa Preta 4x2 - 1 Módulo Com Suporte - Cód. 76071

Placa Preta 4x2 - 2 Módulos Separados Com Suporte - Cód. 76081

Placa Preta 4x2 - 3 módulos Juntos Com suporte - Cód. 76101

## PLACAS 4x4



























Placa Preta 4x4 - Cega Com Suporte - Cód. 77051

Placa Preta 4x4 - 1+1 Módulo Com Suporte - Cód. 77061

Placa Preta 4x4 - 2+2 Módulos Com Suporte - Cód. 77071

Placa Preta 4x4 - 3+3 Módulos Com Suporte - Cód. 77091



 Módulo Interruptor Simples 10A 250V~ Branco - Cód. 7517	 Módulo Interruptor Paralelo 10A 250V~ Branco - Cód. 7522	 Módulo Interruptor Bipolar Simples 10A 250V~ Branco - Cód. 7531	 Módulo Interruptor Bipolar Paralelo 10A 250V~ Branco - Cód. 7532	 Módulo Interruptor Intermediário 10A 250V~ Branco - Cód. 7533	 Módulo Interruptor 25A 250V~ Branco - Cód. 7534	 Módulo Pulsador para Campanha 10A 250V~ Branco - Cód. 7513	 Módulo Campanha Eletrônica Automática Branco - Cód. 7590	
 Módulo Tomada 250V~ Branco 10A - Cód. 75140	 Módulo Tomada 250V~ Branco 20A - Cód. 75141	 Módulo Tomada Vermelha 20A 250V~ Vermelho - Cód. 75142	 Módulo Tom. Tel. RJ11 - 2 fios Branco - Cód. 7561	 Módulo Tomada de Rede RJ45 CAT 5e - 8 Fios Branco - Cód. 7564	 Módulo Tomada de Rede RJ45 CAT 6 - 8 fios Branco - Cód. 75641	 Módulo HDMI Versão 1.4 19 pinos Branco - Cód. 7592	 Módulo Variador de Luz Bivolt 127V - 300W 220V - 500W Branco - Cód. 7566	 Módulo Saída de Fio Branco - Cód. 7503
 Módulo Variador de Ventilador Bivolt 127V - 300W 220V - 500W Branco - Cód. 7567	 Módulo Tomada para Antena de TV Branco - Cód. 7563	 Módulo Protetor MPT bivolt 10A Branco - Cód. 7593	 Módulo Cego Branco - Cód. 7504	 Módulo USB 2A Branco - Cód. 7591		 ACESSE O SITE		



É INOVADOR, É ÚNICO, É ILUMI!

## LANÇAMENTO · VIVAZ PRETA · VIVAZ PRETA · LANÇAMENTO · VIVAZ PRETA · LANÇAMENTO · VIVAZ PRETA ·

 Módulo Interruptor Simples 10A 250V~ Preto - Cód. 75174	 Módulo Interruptor Paralelo 10A 250V~ Preto - Cód. 75224	 Módulo Interruptor Bipolar Simples 10A 250V~ Preto - Cód. 75314	 Módulo Interruptor Bipolar Paralelo 10A 250V~ Preto - Cód. 75324	 Módulo Interruptor Intermediário 10A 250V~ Preto - Cód. 75334	 Módulo Interruptor 25A 250V~ Preto - Cód. 75344	 Módulo Pulsador para Campanha 10A 250V~ Preto - Cód. 75134	 Módulo Campanha Eletrônica Automática Preto - Cód. 75904
 Módulo Tomada 250V~ Preto 10A - Cód. 751404	 Módulo Tomada 250V~ Preto 20A - Cód. 751414	 Módulo Tom. Tel. RJ11 - 2 fios Preto - Cód. 75614	 Módulo Tomada de Rede RJ45 CAT 5e - 8 Fios Preto - Cód. 75644	 Módulo Tomada de Rede RJ45 CAT 6 - 8 fios Preto - Cód. 756414	 Módulo HDMI Versão 1.4 19 pinos Preto - Cód. 75924	 Módulo Tomada para Antena de TV Preto - Cód. 75634	
 Módulo Variador de Ventilador Bivolt 127V - 300W 220V - 500W Preto - Cód. 75674	 Módulo Protetor MPT bivolt 10A Preto - Cód. 75934	 Módulo Cego Preto - Cód. 75044	 Módulo Variador de Luz Bivolt 127V - 300W 220V - 500W Preto - Cód. 75664	 Módulo Saída de Fio Preto - Cód. 75034	 Módulo USB 2A Preto - Cód. 75914		



## módulos Sistema Monobloco by ILUMI

 Módulo 2 Tomadas Separadas Monobloco 250V~ Preto 10A - Cód. 751204	 Módulo 2 Tomadas Separadas Monobloco 250V~ Preto 20A - Cód. 751214	 Módulo 3 Tomadas Juntas Monobloco 250V~ Preto 10A - Cód. 751234	 Módulo 3 Tomadas Juntas Monobloco 250V~ Preto 20A - Cód. 751244	 Módulo 2 Tomadas Separadas Monobloco 250V~ Branco 10A - Cód. 75120	 Módulo 2 Tomadas Separadas Monobloco 250V~ Branco 20A - Cód. 75121	 Módulo 3 Tomadas Juntas Monobloco 250V~ Branco 10A - Cód. 75123	 Módulo 3 Tomadas Juntas Monobloco 250V~ Branco 20A - Cód. 75124
---	---	--	--	---	---	--	--



# INTERRUPTORES E TOMADAS 4x2



- CJ. Interruptor Simples Vertical 10A 250V~ Cód. 8017
- CJ. Interruptor Simples Horizontal 10A 250V~ Cód. 80173
- CJ. Interruptor Paralelo Vertical 10A 250V~ Cód. 8022
- CJ. Interruptor Paralelo Horizontal 10A 250V~ Cód. 80223
- CJ. 2 Interruptores Simples 10A 250V~ Cód. 8018
- CJ. 2 Interruptores Paralelos 10A 250V~ Cód. 8024
- CJ. 3 Interruptores Simples 10A 250V~ Cód. 8019
- CJ.1 Interruptor Simples 10A 250V~ + 1 Tomada 10A Cód. 80200
- CJ. 1 Interruptor Simples 10A 250V~ + 1 Tomada 20A Cód. 80201
- CJ. 1 Interruptor Paralelo 10A + 1 Tomada 10A 250V~ Cód. 80280
- CJ. 1 Interruptor Simples 10A 250V~ + 2 Tomadas 10A Cód. 80203



- CJ. 2 Interruptores Simples 10A + 1 Tomada 10A 250V~ Cód. 80210
- CJ. 2 Interruptores Simples 10A + 1 Tomada 20A 250V~ Cód. 80211
- CJ. 1 Tomada Horizontal 10A 250V~ Cód. 80150
- CJ. 1 Tomada Horizontal 20A 250V~ Cód. 80151
- CJ. 1 Tomada Horizontal 20A 250V~ c/ Tampa Vermelha Cód. 80152
- CJ. 1 Tomada Vertical 250V~ 10A - Cód. 80140
- CJ. 1 Tomada Vertical 20A - Cód. 80141
- CJ. 2 Tomadas 250V~ 10A - Cód. 80120
- CJ. 2 Tomadas 250V~ 20A - Cód. 80121
- CJ. 3 Tomadas 250V~ 10A - Cód. 80123
- CJ. 3 Tomadas 250V~ 20A - Cód. 80124
- CJ. Tomada p/ Antena de TV Horizontal Cód. 80633



CJ. Cigarra Bivolt 127/220V 50/60Hz Cód. 8090



CJ. Saída de fio Horizontal Cód. 8053



Foto ilustrativa com sugestão de montagem modular - Itens: 2 Tomadas 10A 250V~ Cód. 81140, Módulo Protetor MPT 10A Cód. 8193, Placa 4x2 3 módulos juntos c/ Suporte Cód. 82100

## SUPORES



Suporte 4x2 - 1 Módulo Vertical Cód. 8200

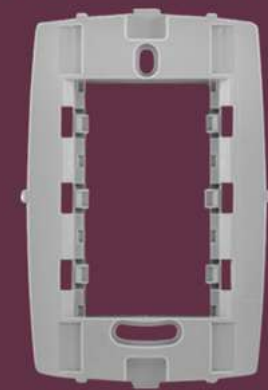

Suporte 4x2 - 3 Módulos Horizontal Cód. 8201

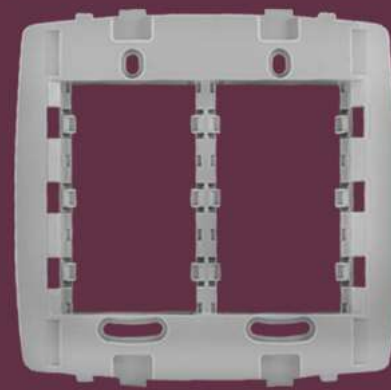

Suporte 4x4 6 Módulos Horizontal Cód. 8202



ACESSE O SITE

slim



## PLACAS 4x2



Placa 4x2 Cega Cód. 8205 Com suporte Cód. 82050



Placa 4x2 1 Módulo Vertical Cód. 8206 Com suporte Cód. 82060



Placa 4x2 1 Módulo Horizontal Cód. 8207 Com suporte Cód. 82070



Placa 4x2 2 Módulos Separados Horizontal Cód. 8208 Com suporte Cód. 82080



Placa 4x2 3 Módulos Juntos Cód. 8210 Com suporte Cód. 82100

proteção UV

## PLACAS 4x4



Placa 4x4 Cega Cód. 8305 Com suporte Cód. 83050



Placa 4x4 1+1 Módulo Separado Horizontal Cód. 8306 Com suporte Cód. 83060



Placa 4x4 2+2 Módulos Separados Horizontal Cód. 8307 Com suporte Cód. 83070



Placa 4x4 3+3 Módulos Juntos Cód. 8309 Com suporte Cód. 83090



# MÓDULOS BRANCOS

Utilizados nas linhas: Slim, Slim Móveis, Box Slim, Lev e CIT/CDT

 Interruptor Simples 10A 250V~ Cód. 8117 Interruptor Paralelo 10A 250V~ Cód. 8122 Interruptor Bipolar Paralelo 10A 250V~ Cód. 8132 Interruptor Intermediário 10A 250V~ Cód. 8133	 Interruptor 25A 250V~ Cód. 8134 Interruptor Bipolar 10A 250V~ Cód. 8131	 Pulsador p/ Minuteria 10A 250V~ Cód. 8100	 Pulsador p/ Campainha 10A 250V~ Cód. 8113	 Tomada 10A 250V~ Cód. 81140 Tomada 20A 250V~ Cód. 81141	 Tomada c/ Tampa Vermelha 20A 250V~ Cód. 81142
 Tomada de Telefone RJ11 - 2 Fios Cód. 8161	 Tomada de Rede Informática RJ45 - cat6 - 8 Fios Cód. 81641 Tomada de Rede Informática RJ45 - cat5e - 8 Fios Cód. 8164	 Cigarra Bivolt Cód. 8190	 Variador de Luz Bivolt 127V~ 300W 220V~ 500W Cód. 8166	 Variador de Ventilador Bivolt 127V~ 300W 220V~ 500W Cód. 8167	
 Tomada Antena de TV Cód. 8163	 Módulo Protetor MPT Bivolt 10A Cód. 8193	 Módulo Saída de Fio Cód. 8103	 Módulo Cego Cód. 8104	 Módulo USB 2A Cód. 8191	

# MÓDULOS PRETOS

Utilizados nas linhas: Slim, Slim Móveis, Box Slim, Lev e CIT/CDT

 Interruptor Simples 10A 250V~ Cód. 81174 Interruptor Paralelo 10A 250V~ Cód. 81224 Interruptor Intermediário 10A 250V~ Cód. 81334	 Pulsador p/ Campainha 10A 250V~ Cód. 81134	 Tomada 10A 250V~ Cód. 811404 Tomada 20A 250V~ Cód. 811414	 Módulo Cigarra 127/220V~ 50/60Hz Cód. 81904
 Interruptor 25A 250V~ Cód. 81344	 Tomada Antena de TV Cód. 81634	 Tomada de Telefone RJ11 - 2 Fios Cód. 81614	
 Tomada de Rede Informática RJ45 - cat5e - 8 Fios Cód. 81644	 Módulo Cego Cód. 81044	 Módulo Saída Fio Cód. 81034	
 Variador de Luz Bivolt 127V~ 300W 220V~ 500W Cód. 81664	 Variador de Ventilador Bivolt 127V~ 300W 220V~ 500W Cód. 81674		

## SLIM MÓVEIS RETANGULAR PLACAS COM SUPORTE





# SLIM BOX

 Conjunto Interruptor Simples 10A 250V~ Cód. 8417	 Conjunto Interruptor 2 Teclas Simples 10A 250V~ Cód. 8418	 Conjunto Interruptor Simples 10A + Tomada 20A 250V~ Cód. 84201	 Conjunto Interruptor Simples + Tomada 10A 250V~ Cód. 84200	 Conjunto 2 Tomadas 10A 250V~ Cód. 84120 2 Tomadas 20A 250V~ Cód. 84121	 Conjunto Tomada 10A 250V~ Cód. 84140
 Conjunto Tomada 20A 250V~ Cód. 84141	 Conjunto Base + Moldura 1 Módulo Cód. 8401	 Conjunto Base + Moldura 2 Módulos Cód. 84011			

## LANÇAMENTO

 Conjunto Base + Moldura 1 Módulo Cód. 84014	 Conjunto Base + Moldura 2 Módulos Cód. 840114
--	--

# MÓDULOS SISTEMA MONOBLOCO

Ao usar a placa Slim retirar a tampa

 Monobloco Duplo 2 Tomadas Separadas 10A 250V Preto~ Cód. 861204 2 Tomadas Separadas 20A 250V Preto~ Cód. 861214	 Monobloco Duplo 2 Tomadas Separadas 10A 250V~ Cód. 86120 2 Tomadas Separadas 20A 250V~ Cód. 86121	 Monobloco Triplo 3 Tomadas Juntas 10A 250V Preto~ Cód. 861234 3 Tomadas Juntas 20A 250V Preto~ Cód. 861244	 Monobloco Triplo 3 Tomadas Juntas 10A 250V~ Cód. 86123 3 Tomadas Juntas 20A 250V~ Cód. 86124
---	---	--	--

# SLIM MÓVEIS



- 1- Fixe o suporte item 2 na madeira item 1 utilizando os parafusos (2x) item 3.
- 2- Encaixe o módulo item 4 (módulo conforme necessidade) no suporte item 3.
- 3- Encaixe a placa item 5 no suporte 2.



NOTA 1:  
-Marque a distância entre os centros de 22mm;  
-Faça 2 furos com serra copo 035mm.

NOTA 2:  
-Marque a distância entre os centros de 22mm;  
-Marque a distância entre os centros de 28mm;  
-Faça 4 furos com serra copo 035mm.

NOTA 3:  
Para utilizar 2 módulos, os suportes devem ser encaixados posicionando o pino no rasgo lateral (conforme detalhe A) e deslocando ambos até os suportes estarem no mesmo nível. Posteriormente fixe-os com os parafusos (2x).

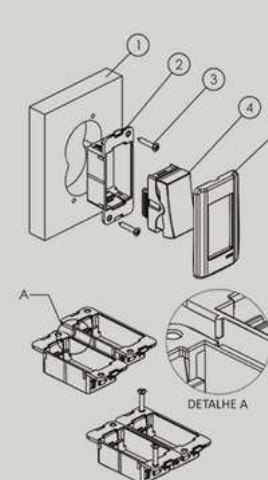

76mm  
Linha Slim para móveis!  
Basta furar com uma serra copo de 76mm e encaixar o suporte!  
Compatível com os módulos da linha Slim!



Placa Suporte Branco  
Cód. 8501



# INTERRUPTORES E TOMADAS 4x2

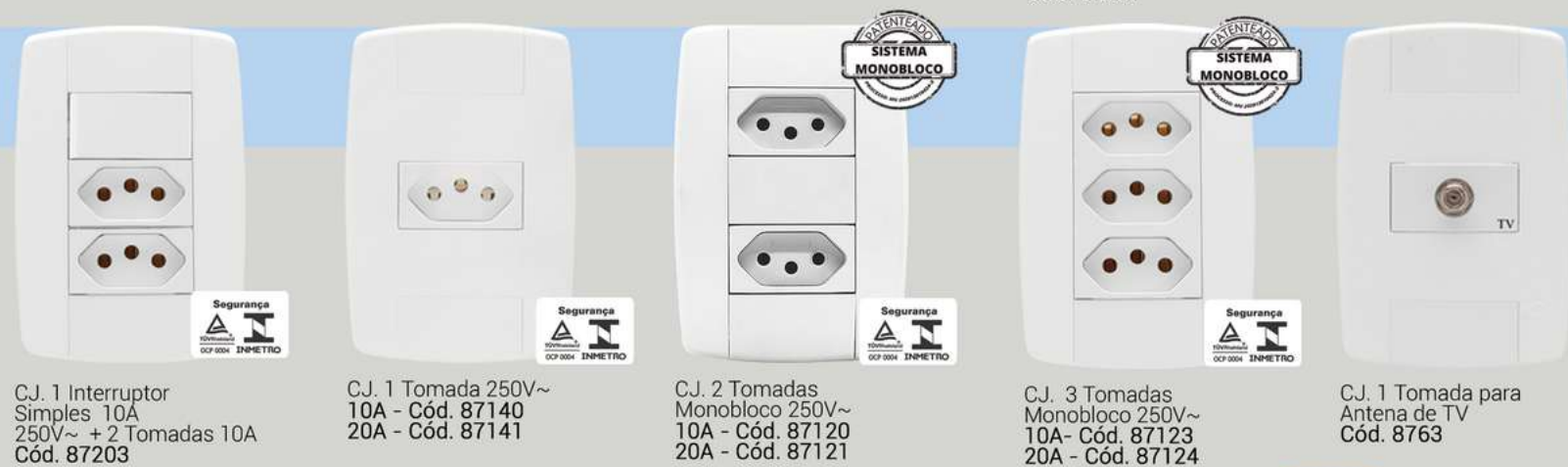

## PLACAS 4x2 Utiliza os mesmos módulos da Slim!



## PLACAS 4x4



# lev

Suporte e placa em uma única peça.



ACESSE O SITE

• LANÇAMENTO • LEV PRETA • LANÇAMENTO • LEV PRETA • LANÇAMENTO • LEV

## PLACAS 4x2



Placa 4x2 Cega Cód. 8805

Placa 4x2 1 Módulo Cód. 8807

Placa 4x2 2 Módulos Separados Cód. 8808

Placa 4x2 1 Módulo Largo Cód. 8809

Placa 4x2 3 Módulos Cód. 8810

proteção UV

## PLACAS 4x4

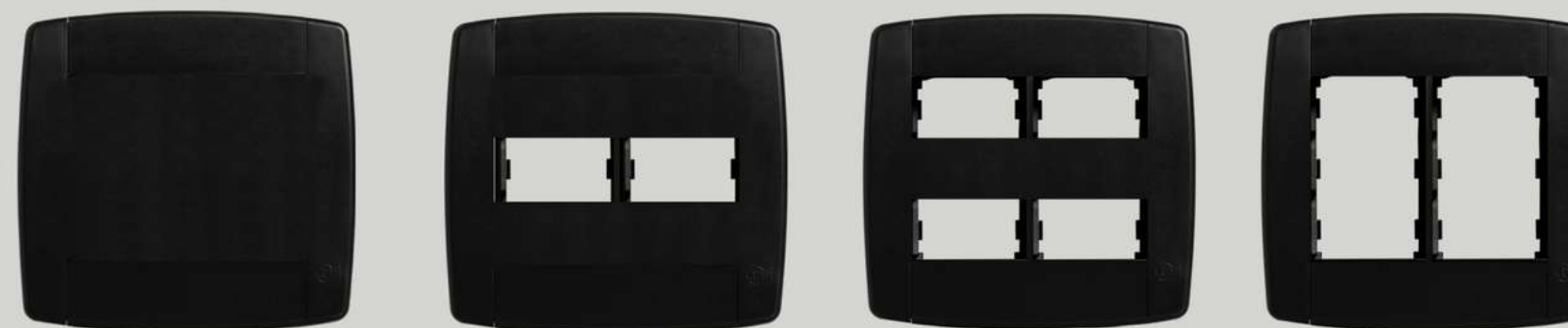

Placa 4x4 Cega Cód. 89050

Placa 4x4 1+1 Módulo Separado Horizontal Cód. 89060

Placa 4x4 2+2 Módulos Separados Horizontal Cód. 89070

Placa 4x4 3+3 Módulos Juntos Cód. 89090

Utiliza os mesmos módulos da Slim!





# INTERRUPTORES E TOMADAS 4x2



CJ. Interruptor 1 Tecla Simples: Cód. 2217 Paralela: Cód. 2222

CJ. Interruptor 2 Teclas Simples: Cód. 2218 Paralela: Cód. 2224

CJ. Interruptor 3 Teclas Simples: Cód. 2219

CJ. Tomada Fixa de Embutir 2P + T 250V~ 10A - Cód. 22140 20A - Cód. 22141

CJ. 2 Tomadas 2P + T 250V~ 10A - Cód. 22120 20A - Cód. 22121



CJ. 2 Tomadas Monobloco 250V~ 10A - Cód. 22120 20A - Cód. 22121

CJ. 3 Tomadas Monobloco 250V~ 10A - Cód. 221201 20A - Cód. 221211

CJ. Interruptor 1 Tecla Simples + Tomada Fixa de Embutir 2P+T 20A 250V~ Cód. 22201

CJ. Interruptor 1 Tecla Simples + Tomada Fixa de Embutir 2P+T 10A 250V~ Cód. 22200

CJ. Interruptor 1 Tecla Paralela + Tomada Fixa de Embutir 2P + T 10A 250V~ Cód. 22280

CJ. Interruptor 2 Teclas Simples + Tomada Fixa de Embutir 2P+T 10A 250V~ Cód. 22210



CJ. Interruptor 2 Teclas Simples + Tomada Fixa de Embutir 2P+T 20A 250V~ Cód. 22211

CJ. Pulsador para Campanha Cód. 2213

Conjunto Cigarra de Embutir Bivolt Cód. 2290

Conjunto Conector Antena TV Cód. 2263



ACESSE O SITE

proteção UV

placas + largas



## PLACAS 4x2



Placa 4x2 Cega Cód. 2254

Placa 4x2 para Interrup. 1 Tecla Cód. 2249

Placa 4x2 para Interrup. 2 Teclas Cód. 2250

Placa 4x2 para Interrup. 3 Teclas Cód. 2251

Placa 4x2 para 2 Tomadas Fixas de Embutir Cód. 22410



Placa 4x2 para 1 Tecla + Tomada Fixa de Embutir Cód. 22420

Placa 4x2 para 1 Tomada Fixa de Embutir Cód. 22400

Placa 4x2 com Saída de Fio Cód. 2253

Placa 4x2 para 1 Tomada Redonda Cód. 2248

## PLACAS 4x4



Placa 4x4 Cega Cód. 344A

Placa 4x4 com Saída de Fio Cód. 345B



# INTERRUPTORES E TOMADAS 4x2



CJ. Interruptor 1 Tecla Simples: Cód. 2017  
Paralelo: Cód. 2022



CJ. Interruptor 2 Teclas Simples Cód. 2018  
CJ. Interruptor 1 Simples + 1 Paralela Cód. 2023  
CJ. Interruptor 2 Paralelas Cód. 2024



CJ. Interruptor 3 Teclas Simples Cód. 2019  
CJ. Interruptor 2 Simples + 1 Paralelo Cód. 2025  
CJ. Interruptor 1 Simples + 2 Paralelos Cód. 2026  
CJ. Interruptor 3 Paralelos Cód. 2027



CJ. Interruptor 1 Tecla Simples + Tomada Fixa Embutir 2P+T 10A 250V~ Cód. 20200  
CJ. Interruptor 1 Tecla Paralela + Tomada Fixa Embutir 2P+T 10A 250V~ Cód. 20280



CJ. Interruptor 1 Tecla Simples + Tomada Fixa Embutir 2P+T 20A 250V~ Cód. 20201  
CJ. Interruptor 1 Tecla Paralela + Tomada Fixa Embutir 2P+T 20A 250V~ Cód. 20281



CJ. Interruptor 2 Teclas Simples + Tomada Fixa Embutir 2P+T 10A 250V~ Cód. 20210  
CJ. Interruptor 1 Tecla Simples + 1 Paralela + Tomada 2P+T 10A 250V~ Cód. 20290  
CJ. Interruptor 2 Teclas Paralelas + Tomada 2P+T 10A 250V~ Cód. 20300



CJ. Interruptor 2 Teclas Simples + Tomada Fixa Embutir 2P+T 20A 250V~ Cód. 20211



CJ. Tomada Fixa Embutir 2P+T 250V~ 10A - Cód. 20140  
20A - Cód. 20141



CJ. Tomada Fixa Embutir Vermelha 2P+T 250V~ 10A - Cód. 20142  
20A - Cód. 20143



CJ. 2 Tomadas 10A 250V~ Cód. 20120  
CJ. 2 Tomadas 20A 250V~ Cód. 20121



CJ. 2 Tomadas Monobloco 10A 250V~ Cód. 201200  
CJ. 2 Tomadas Monobloco 20A 250V~ Cód. 201210



CJ. 3 Tomadas Monobloco 10A 250V~ Cód. 201201  
CJ. 3 Tomadas Monobloco 20A 250V~ Cód. 201211



CJ. Interruptor Bipolar 10A 250V~ Cód. 2031  
CJ. Interruptor Intermediário 10A 250V~ Cód. 2032



CJ. Interruptor Bipolar 25A 250V~ Cód. 2033



CJ. Pulsador para Minuteria Cód. 2000

# stylus



CJ. Pulsador para Campanha Cód. 2013



CJ. Conector Antena TV Cód. 2553



CJ. Controle Ventilação c/ Acionamento de Lâmpada e Inversão de Sentido Rotacão Bivolt 127V~/300w 220V~/500w Cód. 2567



CJ. Cigarra de Embutir 127/220V~ Bivolt Cód. 2690



CJ. Tomada Telebras Modular RJ11 - 2 Fios Cód. 2551



CJ. Tomada de Rede RJ45 CAT5e - 8 Fios Cód. 2554



CJ. RJ51 Tomada Telefone RJ11 - 2 fios Cód. 2565

proteção UV



ACESSE O SITE



# CONJUNTOS SEM PLACA

AGORA ALTERADO PARA SERVIR EM CAIXAS DE CONDULETE

Serve para Stylus, Safira e Pratika



Tomada Fixa de Embutir  
2P+T 10A 250V ~ S/ PL 4x2  
Cód. 20140/0  
Tomada Fixa de Embutir  
2P+T 20A 250V ~ S/ PL 4x2  
Cód. 20141/0



Tomada Fixa De Embutir  
2P+T 20A 250V ~  
VERM. S/ PL 4x2  
Cód. 20143/0



2 Tomada Fixa de Embutir  
2P+T 10A 250V ~ S/ PL 4x2  
Cód. 20120/0  
2 Tomada Fixa de Embutir  
2P+T 20A 250V ~ S/ PL 4x2  
Cód. 20121/0



Pulsador P/ Campainha  
6A 250V ~ S/ PL 4x2  
Cód. 2013/0



Int. 1 Tecla Simples  
6A 250V ~ S/ PL 4x2  
Cód. 2017/0  
Int. 1 Tecla Paralela  
6A 250V ~ S/ PL 4x2  
Cód. 2022/0



Int. 2 Tecla Simples  
6A 250V ~ S/ PL 4x2  
Cód. 2018/0  
Int. 2 Tecla Paralela  
6A 250V ~ S/ PL 4x2  
Cód. 2024/0



Int. 3 Tecla Simples  
6A 250V ~ S/ PL 4x2  
Cód. 2019/0



Int. 1 Tecla Bipolar  
6A 250V ~ S/ PL 4x2  
Cód. 2031/0



Int. 1 Tecla Simples +  
Tom. Fixa Embutir Bip.  
2P+T 6A/10A 250V ~  
S/ PL 4x2  
Cód. 20200/0  
Inter. 1 Tecla Paralela  
+ Tomada Fixa Embutir 2P+T  
10A 250V ~ S/ PL 4x2  
Cód. 20280/0



Inter. 1 Tecla Simples +  
Tomada Fixa Embutir  
2P+T 20A 250V ~  
S/ PL 4x2  
Cód. 20201/0  
Inter. 1 Tecla Paralela +  
Tomada Fixa  
Embutir 2P+T 20A  
250V ~ S/ PL 4x2  
Cód. 20281/0



Tom. Telebras +  
RJ11 MOD. S/ PL 4x2  
Cód. 2551/0

**stylus**

BASTA RECORTAR  
PARA VIRAR  
SAÍDA DE FIO



Placa Cega Redonda 4"  
Cód. 20441



Placa Cega Redonda 3"  
Cód. 20440



## PLACAS 4x2



Placa 4x2 para 1  
Tomada Redonda  
Cód. 2048



Placa 4x2 para  
Interrup. 1 Tecla  
Cód. 2049



Placa 4x2 para  
Interrup. 2 Teclas  
Cód. 2050



Placa 4x2 para  
Interrup. 3 Teclas ou  
1 Tecla + 2 Tomadas  
Cód. 2051



Placa 4x2 para 2 Teclas +  
Tomada Fixa de Embutir  
Cód. 20430



Placa 4x2 com  
Saída de Fio  
Cód. 2053



Placa 4x2 Cega  
Cód. 2054



Placa 4x2 para 1  
Tomada Fixa de Embutir  
Cód. 20400



Placa 4x2 para 2  
Tomada Fixa de Embutir  
Cód. 20410



Placa 4x2 para 1 Tecla +  
1 Tomada Fixa de Embutir  
Cód. 20410

## PLACAS 4x4



Placa 4x4 para Tomada  
Fixa de Embutir  
+ Interrup. 1 Tecla  
Cód. 249F1



Placa 4x4 para Tomada  
Fixa de Embutir +  
Saída de Fio  
Cód. 267Z



Placa 4x4 para 2  
Tomadas Redondas  
Cód. 248E



Placa 4x4 para 2  
Interrup. 1 Tecla  
Cód. 250G



Placa 4x4 para Tomada  
Fixa de Embutir +  
Interrup. 2 Teclas  
Cód. 253J1



Placa 4x4 para  
Saída de Fio  
Cód. 245B



Placa 4x4 para 2  
Interrup. 2 Teclas  
Cód. 252I

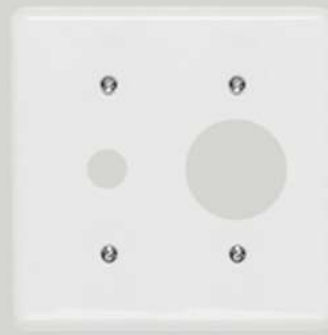

Placa 4x4 para Saída de  
Fio + Tomada Redonda  
Cód. 247D



Placa 4x4 para Tomada Fixa  
de Embutir + Tomada  
Fixa de Embutir  
Cód. 248E1



Placa 4x4 para 2  
Interrup. 3 Teclas  
Ou 2 Interrup. 1 Tecla + 2  
Tomadas  
Cód. 257N



Placa 4x4 Cega  
Cód. 244A



# INTERRUPTORES E TOMADAS 4x2

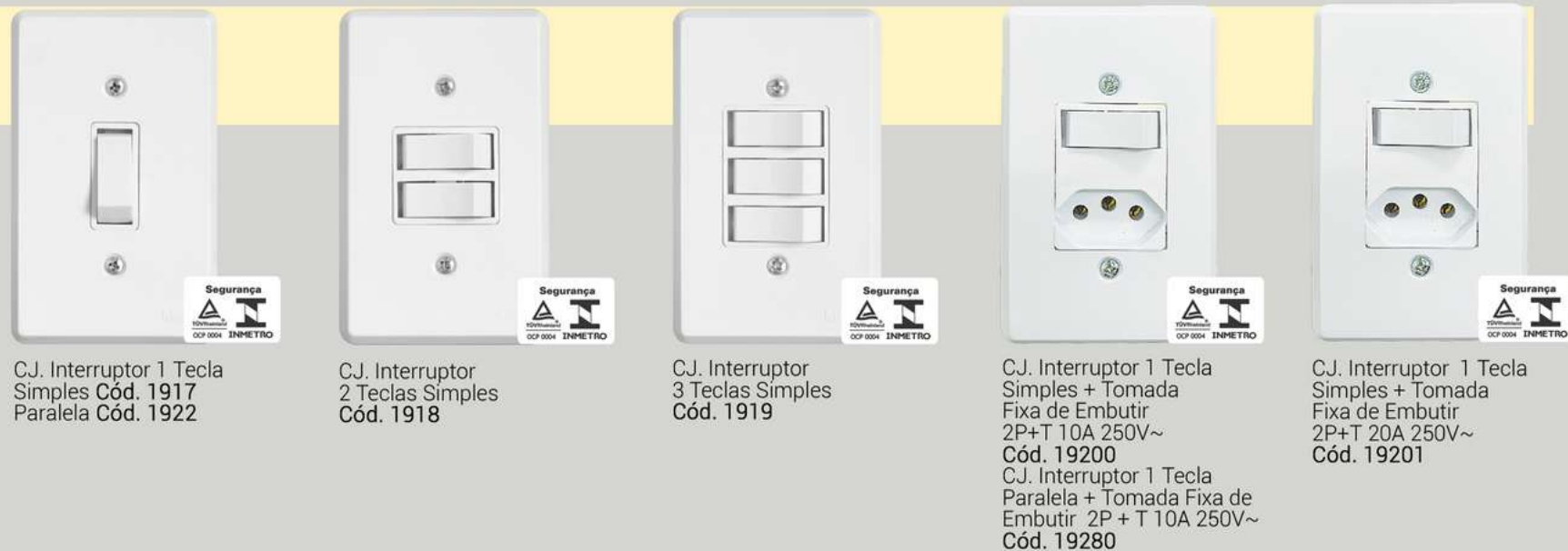

CJ. Interruptor 1 Tecla Simples Cód. 1917  
Paralela Cód. 1922

CJ. Interruptor 2 Teclas Simples Cód. 1918

CJ. Interruptor 3 Teclas Simples Cód. 1919

CJ. Interruptor 1 Tecla Simples + Tomada Fixa de Embutir 2P+T 10A 250V~ Cód. 1920  
CJ. Interruptor 1 Tecla Paralela + Tomada Fixa de Embutir 2P + T 10A 250V~ Cód. 1928

CJ. Interruptor 1 Tecla Simples + Tomada Fixa de Embutir 2P+T 20A 250V~ Cód. 1921



CJ. Interruptor 2 Tecla Simples + Tomada Fixa Embutir 2P+T 10A 250V~ Cód. 19210

CJ. Interruptor 2 Tecla Simples + Tomada Fixa Embutir 2P+T 20A 250V~ Cód. 19211

CJ. Tomada Fixa de Embutir 2P+T 250V~ 10A Cód. 19140  
20A Cód. 19141

CJ. Tomada Fixa de Embutir Vermelha 2P+T 250V~ 10A Cód. 19142  
20A Cód. 19143

CJ. 2 Tomadas Fixas de Embutir 2P+T 250V~ 10A Cód. 19120  
20A Cód. 19121



CJ. Cigarra Embutir 127/220V ~ Bivolt Cód. 1990

CJ. Pulsador para Campanha Cód. 1913

CJ. Interruptor Bipolar 25A 250V~ Cód. 1933



ACESSE O SITE

*pratika*  
branca



## PLACAS 4x2



Placa 4x2 para 1 Tomada Redonda Cód. 1948

Placa 4x2 com Saída de Fio Cód. 1953

Placa 4x2 Cega Cód. 1954

## PLACAS 4x4



Placa 4x4 Cega Cód. 444A

Placa 4x4 com 1 Saída de Fio Cód. 445B

A PRATICIDADE QUE SEU LAR MERECE!



# box

# sobrepor

# proteção UV



CJ. Interruptor 1 Tecla Simples  
Cód. 6317  
Paralelo  
Cód. 6322

CJ. Interruptor 2 Teclas Simples  
Cód. 6318  
CJ. Interruptor 2 Teclas Paralelos  
Cód. 6324

CJ. Interruptor 3 Teclas Simples  
Cód. 6319

CJ. Pulsador para Campainha  
Cód. 6313

CJ. Tomada Fixa 2P+T 10A 250V~  
Cód. 63140  
CJ. Tomada Fixa 2P+T 20A 250V~  
Cód. 63141



CJ. Interruptor 25A 250V~  
Cód. 6333

CJ. Interruptor 10A 250V~  
Cód. 6331

CJ. Tomada de Rede CAT5e - RJ45 - 8 Fios  
Cód. 6364

CJ. Tomada Fixa 2P+T 20A 250V~  
Cód. 63143

CJ. 2 Tomadas Fixas 2P+T 10A 250V~  
Cód. 63120  
20A 250V~  
Cód. 63121



CJ. Interruptor 1 Tecla Simples + Tomada 2P+T 10A 250V~  
Cód. 63200

CJ. Tomada para Antena TV  
Cód. 6363

CJ. Tomada de Telefone RJ11 - 2 Fios  
Cód. 6365

CJ. Tomada Telebras RJ11 - 2 Fios Modular  
Cód. 6361

Placa Cega  
Cód. 6254

CJ. Interruptor 1 Tecla Paralela + Tomada 2P + T 10A 250V~  
Cód. 63280  
CJ. Interruptor 1 Tecla Simples 6A com Tomada 2P + T 20A 250~  
Cód. 63201



Caixa de Sobrepor 4x2 Branca  
Cód. 62061  
Cód. 62061PCT

Caixa para Canaleta Branca  
Cód. 6206



ACESSE O SITE

## Caixa Sobrepor 4x2



### Modo de instalação:

- 1- Remova o pino provisório.
- 2- Desencaixe a placa.
- 3- Retire o parafuso de dentro da caixa.
- 4- Parafuse o produto e a placa na caixa de sobrepor.

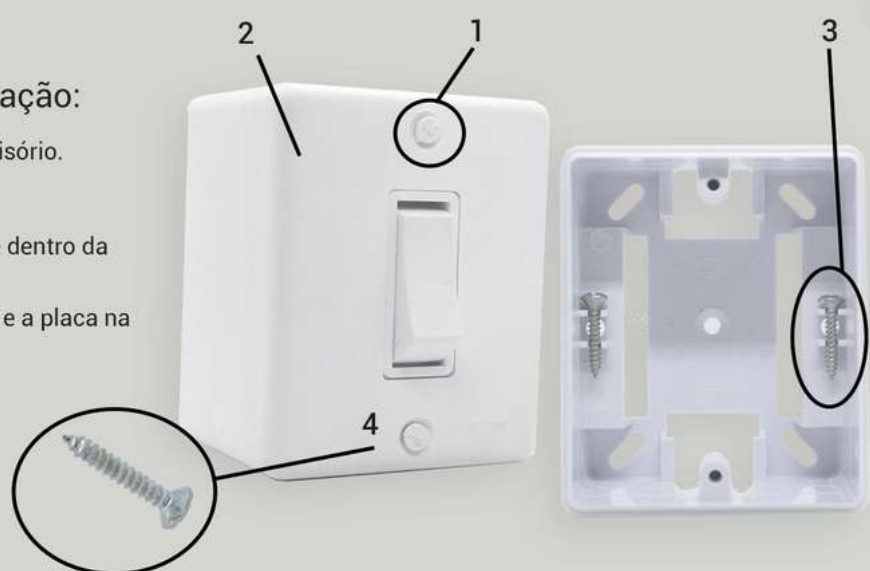

## econômica



CJ. Interruptor Externo Sobrepor Simples 6A  
Cód. 1755

CJ. Interruptor Externo Sobrepor 2 Teclas Simples 6A  
Cód. 1656  
Cód. 1656PCT

CJ. Interruptor Externo de Sobrepor Simples + Tomada 2P + T 20A 250V~  
Cód. 16541  
Cód. 16541PCT



CJ. Tomada Redonda Sobrepor Externo 2P+T 10A 250V~  
Cód. 16510  
Cód. 16510PCT  
20A 250V~  
Cód. 16511  
Cód. 16511PCT

CJ. Tomada Redonda Sobrepor Externo 2P+T 10A 250V~  
Cód. 17500

### Opções de Embalagens - Econômica

CÓDIGO	IND.	PCT	PG	S
17500	X	X	X	
1755	X	X	X	X

### Opções de Embalagens - Retangular

CÓDIGO	IND.	PCT
16582	X	
16516	X	X
16517	X	X
16562	X	
16518	X	X
16519	X	X
16544	X	X
16545	X	X
16553	X	X



CJ. Interruptor Sobrepor Retangular Simples 250V ~  
Cód. 16553

CJ. Interruptor Sobrepor Retangular 2 TCS Simples.  
Cód. 16562

CJ. Tomada Sobrepor Retangular Bipolar 2P+T 10A 250V~  
Cód. 16516  
20A 250V~  
Cód. 16517



CJ. 2 Tomadas Sobrepor Retangular Bipolar 2P+T 10A 250V~  
Cód. 16518  
20A 250V~  
Cód. 16519

CJ. Interruptor Sobrepor Retangular 1 TC Simp. + 1 Tom. 2P+T 10A 250V ~  
Cód. 16544  
20A 250V ~  
Cód. 16545

CJ. Pulsador p/ Campainha Sobrepor Retangular  
Cód. 16582

## retangular



## pinos & adaptadores



ACESSE O SITE



Pino Robusto 2P 20A 250V~  
Cinza: Cód. 1402PCT  
Branco: Cód. 1434PCT

Pino Robusto 2P+T 20A 250V~  
Cinza: Cód. 1406PCT  
Branco: Cód. 1436PCT



Pluque Fêmea 2P 10A 250V~  
Cinza: Cód. 1429  
Preto: Cód. 1430  
Branco: Cód. 1444  
20A 250V~  
Cinza: Cód. 1420  
Preto: Cód. 1421  
Branco: Cód. 1441



Pluque Fêmea 2P+T 10A 250V~  
Cinza: Cód. 1431  
Preto: Cód. 1432  
Branco: Cód. 1433  
20A 250V~  
Cinza: Cód. 1422  
Preto: Cód. 1423  
Branco: Cód. 1442



Pino Prensa Cabo 2P 10A 250V~  
Cinza: Cód. 14010  
Preto: Cód. 14030  
Branco: Cód. 14240



Pino Prensa Cabo 2P+T 10A 250V~  
Cinza: Cód. 14050  
Preto: Cód. 14070  
Branco: Cód. 14350



Pino Prensa Cabo 2P 20A 250V~  
Cinza: Cód. 14011  
Preto: Cód. 14031  
Branco: Cód. 14241



Pino Prensa Cabo 2P+T 20A 250V~  
Cinza: Cód. 14051  
Preto: Cód. 14071  
Branco: Cód. 14351

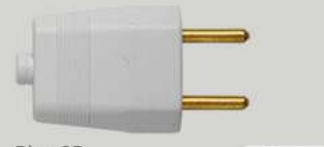

Pino 2P 10A 250V~  
Cinza: Cód. 1401PCT  
Preto: Cód. 1403PCT



Pino 2P+T 10A 250V~  
Cinza: Cód. 1405PCT  
Preto: Cód. 1407PCT



Pino Prensa Cabo Gigante 2P 10A 250V~  
Cinza: Cód. 1412  
Preto: Cód. 1414  
Branco: Cód. 1437



Pino Prensa Cabo Gigante 2P+T 10A 250V~  
Cinza: Cód. 1416  
Preto: Cód. 1418  
Branco: Cód. 1439



Pino Prensa Cabo Gigante 2P 20A 250V~  
Cinza: Cód. 1413  
Preto: Cód. 1415  
Branco: Cód. 1438



Pino Prensa Cabo Gigante 2P+T 20A 250V~  
Cinza: Cód. 1417  
Preto: Cód. 1419  
Branco: Cód. 1440



Pluque Fêmea Gigante 2P+T 20A 250V~  
Cinza: Cód. 1449  
Preto: Cód. 1450



Pino Triangular 2P 10A 250V~  
Cinza: Cód. 1427  
Preto: Cód. 1428  
Branco: Cód. 1443



Pino Prensa Cabo Extra Gigante Bipolar 2P 10A 250V~ NBR 14136  
Cinza: Cód. 14121



Pino Prensa Cabo Extra Gigante Bipolar 2P 20A 250V~ NBR 14136  
Cinza: Cód. 14131



Pino Prensa Cabo Extra Gigante 2P+T 10A 250V~ NBR 14136  
Cinza: Cód. 14161



Pino Prensa Cabo Extra Gigante 2P+T 20A 250V~ NBR 14136  
Cinza: Cód. 14171

Opções de Embalagens - Fêmea

CÓDIGO	IND	PCT	P	PG
1429	X	X	X	X
1430	X	X		
1444	X	X		X
1420	X	X	X	
1421	X	X		
1441	X	X		X
1431	X	X	X	X
1432	X	X		X
1433	X	X		X
1422	X	X	X	X
1423	X	X		X
1442	X	X		X

Opções de Embalagens - Pino Macho

CÓDIGO	IND	PCT	P	PG
1401		X		
1403		X		
1405		X		
1407		X		
14010	X	X	X	X
14240	X	X		X
14030	X	X		X
14011	X	X		X
14241	X	X		X
14031	X	X		X
14050	X	X		X
14350	X	X		X
14070	X	X		X
14051	X	X		X
14351	X	X		X
14071	X	X		X

Opções de Embalagens - Pino Gigante - Pino Extra Gigante

CÓDIGO	IND	PCT	P	PG
1412	X	X	X	X
1414	X	X	X	X
1437	X	X		X
1413	X	X		X
1415	X	X		X
1416	X	X		X
1417	X	X		X
1418	X	X		X
1419	X	X		X
1438	X	X		X
1439	X	X		X
1440	X	X		X
1449	X	X		X
1450	X	X		X
14121	X			
14131	X	X		
14161	X	X		
14171	X	X		

Opções de Embalagens - Pino Triangular

CÓDIGO	IND	PCT
1427	X	X
1428	X	X
1443	X	X

DESCRIÇÃO	INDIVIDUAL	BLISTER	PACOTE	POTE PEQUENO	POTE GRANDE
SIGLA	IND	B ou BL	PCT	P ou PP	PG
EX. CÓDIGO	14010	14010B	14010PCT	14010P	14010PG



Quando acender apenas a luz verde a tomada é 110/127V~

Quando acender a luz verde + a luz vermelha a tomada é 220V~

Opções de Embalagens - Pino Teste

CÓDIGO	BL	PCT	PP
1445	X	X	X
1445PCTPS		X	

Teste Tensão Cód. 1445B  
Cód. 1445PCT  
Pacote c/ 10 peças  
Cód. 1445PP  
Pote c/ 25 peças

Protetor Tomada Pote  
Cód. 13442PP  
Pacote  
Cód. 13442PCT  
Blister  
Cód. 13442B



Interrup. Meio Cordão 6A  
Branco: Cód. 1647  
Cinza: Cód. 1649

Opções de Embalagens - Interruptor Meio Cordão

CÓDIGO	IND	P	PCT
1647	X	X	X
1649	X	X	X



## NÃO OBSTRUI A TECLA



Adaptador 2P Chato 10A 250V~  
Cinza: Cód. 1207

Pino 3 Saídas Tipo "T" 2P+T 10A 250V~  
Cinza: Cód. 12250  
Branco: Cód. 12270

Pino 3 saídas Tipo "T" 2P 10A 250V~  
Cinza: Cód. 1213  
Branco: Cód. 1215

Opções de Embalagens - Pino 3 Saídas Tipo "T"

CÓDIGO	IND	BL	PCT	PG
1213	X		X	X
1215	X	X		
12250	X		X	X
12270	X	X	X	X

Opções de Embalagens - Adaptadores

CÓDIGO	IND	PCT	BL
1207	X		
1209	X	X	
1211	X	X	X
1218	X	X	
12121	X	X	
12071	X		



Pino Adaptador 2P+T 10A 250V~  
Cinza: Cód. 1209  
Branco: Cód. 1211



Pino Adaptador 3P Chato 20A 250V~  
Cinza: Cód. 1216  
Branco: Cód. 1218



Pino Adaptador 2P Universal 10A 250V~  
Branco: Cód. 12121  
Cinza: Cód. 12071



Pino Adaptador 2P+T Universal 10A 250V~  
Branco: Cód. 12111  
Cinza: Cód. 12091  
Preto: Cód. 12101



# canaletas

## FECHADAS

Canaleta Fechada para Painel Elétrico 20x20x2000mm Branca: Cód. 62094

Canaleta Fechada para Painel Elétrico 30x30x2000mm Branca: Cód. 62095

Canaleta Fechada para Painel Elétrico 50x50x2000mm Branca: Cód. 62096



Canaleta s/ Divisória 20x10x2000mm Branca: Cód. 6209



Canaleta com Divisória 20x10x2000mm Branca: Cód. 62091



Canaleta com Divisória 40x16x2000mm Branca: Cód. 62092



Canaleta com Divisória 50x20x2000mm Branca: Cód. 62093

## COM DUPLA FACE

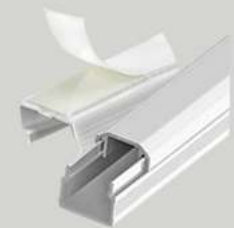

Canaleta 10x10x2000mm Branca Cód. 620913DF



Canaleta Importada 10x10x2000mm Branca Cód. 620916DF



Canaleta Importada com divisória 20x10x2000mm Branca Cód. 620917DF



Canaleta 20x10x2000mm Branca Cód. 6209DF

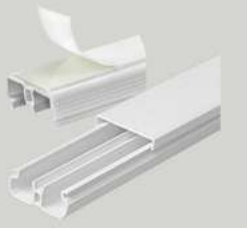

Canaleta com Divisória 20x10x2000mm Branca Cód. 62091DF



Canaleta Importada 20x10x2000mm Branca Cód. 620915DF



Canaleta com Divisória 40x16x2000mm Branca Cód. 62092DF

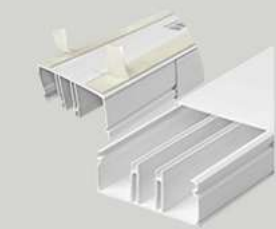

Canaleta com Divisória 50x20x2000mm Branca Cód. 62093DF

## LANÇAMENTOS

Canaleta com Divisória 20x10x1000mm Branca Cód. 62081DF

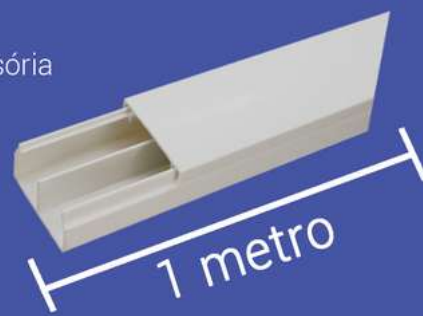

Canaleta com Divisória 20x10x2000mm Preta c/ Fita DF Cód. 64091DF



## SEMIABERTAS



Canaleta Semiaberta 20x20x2000mm Cinza: Cód. 19093 Branca: Cód. 62098



Canaleta Semiaberta 30x30x2000mm Cinza: Cód. 19095 Branca: Cód. 620910



Canaleta Semiaberta 50x50x2000mm Cinza: Cód. 19097 Branca: Cód. 620912



ACESSE O SITE



Canaleta Aberta 50x50x2000mm Branca: Cód. 620911 Cinza: Cód. 19098



Canaleta Aberta 20x20x2000mm Branca: Cód. 62097 Cinza: Cód. 19094

Canaleta Aberta 30x30x2000mm Branca: Cód. 62099 Cinza: Cód. 19096

## ABERTAS

## CONEXÕES



Tipo T 20x10 Cód. 6204 Cód. 6204PCT



Cotovelo 90° 20x10 Cód. 6201 Cód. 6201PCT



Luva 20x10 Cód. 6205 Cód. 6205PCT



Cotovelo Interno 40x16: Cód. 62020 50x20: Cód. 62021



Cotovelo Interno 20x10 Cód. 6202 Cód. 6202PCT



Cotovelo Externo 20x10 Cód. 6203 Cód. 6203PCT



Cruzeta 20x10 Cód. 6207



Cotovelo Externo 40x16: Cód. 62030 50x20: Cód. 62031



Tipo T 40x16: Cód. 62040 50x20: Cód. 62041



Luva 40x16: Cód. 62050



Cotovelo 90° 40x16: Cód. 62010 50x20: Cód. 62011

## CONEXÕES PRETAS

LANÇAMENTO · CONEXÕES PRETAS · LANÇAMENTO · CONEXÕES PRETAS · LANÇAMENTO · CONEXÕES



Cotovelo 90° 20x10 PT Cód. 62014PCT



Cotovelo Interno 20x10 PT Cód. 62024PCT



Cotovelo Externo 20x10 PT Cód. 62034PCT



Tipo T 20x10 PT Cód. 62044PCT



Luva 20x10 Cód. 62054PCT



Cruzeta 20x10 Cód. 62074



# caixas & quadros



ACESSE O SITE

## EMBUTIR



CIT Caixa de ligação p/ Int. 25A + Tom. 20A 250V~ - Emb. Cód. 62064

CDT Caixa de ligação p/ Disjuntor + Tom. 20A 250V~ - Emb. Cód. 62063

CDT Caixa de ligação com Disjuntor Unipolar 25A + Tom. 20A 250V~ - Emb. Cód. 620633

Pode ser usado para 2 disjuntores unipolar ou Bipolar 2 entradas



CDT Caixa de ligação compacta p/ disjuntor unipolar + Tom. 20A 250V~ - Sob. Sem Disj. - Cód. 620635  
Com Disj. - Cód. 6206351

## SOBREPOR (AR-CONDICIONADO)



CIT Caixa de ligação p/ Int. 25A + Tom. 20A 250V~ - Sob. Cód. 620641

CDT Caixa de ligação com Disjuntor Unipolar 25A + Tom. 20A 250V~ - SOB. Cód. 620634

CDT Caixa de ligação p/ Disjuntor Unipolar + Tom. 20A 250V~ - Sob. 1 DIN - Cód. 620631  
CDT Caixa de ligação p/ Disjuntor Bip. + Tom. 20A 250V~ - Sob. 2 DIN - Cód. 620632

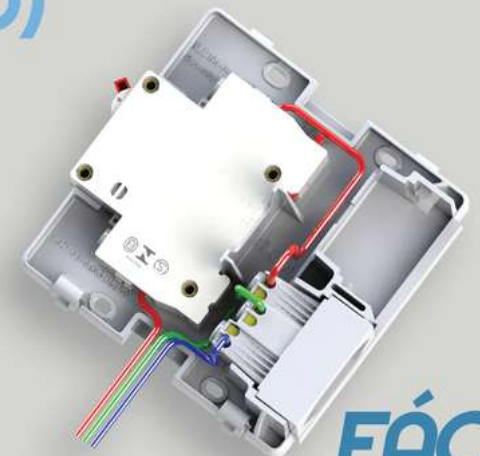

**FÁCIL INSTALAÇÃO**

## CAIXAS 4x2 e 4x4



Caixa de luz embutir 4x4 e 4x2 amarela  
Conforme NBR IEC 60670-1  
Cód. 620621S 4x2  
Cód. 620621PCT 4x2  
Cód. 620622S 4x4

## LANÇAMENTO CAIXA PRETA



Caixa de luz embutir 4x2 Preta  
Cód. 620623PCT 4x2

AS LINHAS DE CAIXAS E QUADROS ILUMI DÃO SEGURANÇA E FLEXIBILIDADE PARA A REALIZAÇÃO DOS PROJETOS DE DISTRIBUIÇÃO DE ENERGIA. PRATICIDADE E PROTEÇÃO INTEGRANDO OS AMBIENTES.

## QUADROS DE DISTRIBUIÇÃO

### EMBUTIR



### SOBREPOR

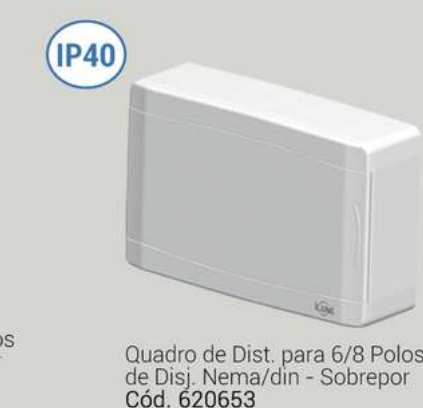

Grau de proteção



**IP 40**  
• Protegido contra objetos sólidos maiores que 1mm.  
• Sem proteção contra água.  
• Pode ser utilizado somente em ambiente interno.

### EMBUTIR



### SOBREPOR

## CAIXAS DE PASSAGEM

### EMBUTIR



### SOBREPOR





# SOQUETES

# iluminação

# PLAFONS



ACESSE O SITE



Soquete Fixo 2A  
150W 250V~  
Preto: Cód. 1606



Soquete Fixo 2A  
150W 250V~  
Branco: Cód. 1607



Soquete Fixo 25°  
2A 150W 250V~  
Preto: Cód. 1604



Soquete de porcelana  
4A 250V~  
Cód. 16010  
Cód. 16010s



Tomada para Lâmpada  
Fluorescente T8 e T10  
2A 250V~  
Cód. 1620  
50 peças: Cód. 1620PCT



Soquete Bipolar  
com Pino Maciço  
4A 150W 250V~  
Preto: Cód. 1701



Soquete Bipolar  
com Pino Maciço 4A 150W  
Branco: Cód. 1703



Soquete em Nylon  
com Borne 2A 250V~  
sem rabicho  
Branco: Cód. 1602  
Branco: Cód. 1602PCT



Soquete com Rabicho  
2A 250V~ econômico  
Preto: Cód. 16101  
Cód. 16101PCT  
Cód. 16101S



Soquete com Rabicho  
2A 250V~  
Preto: Cód. 1610



Soquete com Rabicho  
2A 250V~  
Branco: Cód. 1612



Soquete POP com  
Rabicho Preto 2A 250V~  
Cód. 16103PCT  
Cód. 16103S  
Cód. 16103EC



Soquete sem Chave  
com Borne 2A 250V~  
Preto: Cód. 1600  
10 peças: Cód. 1600PCT

### Opções de embalagens - Soquete

CÓDIGO	IND	BL	PCT	P	PG	S	EC
1606	X	X	X			X	
1607	X		X			X	
1600	X		X		X	X	X
1701	X	X	X		X	X	
1703	X		X				
16103			X			X	X
1620	X		X				
1610	X		X		X	X	X
1612	X		X		X	X	
1604	X						

## Informações técnicas

Bucha c/ 0,25mm de espessura.

Receptáculo de Porcelana.

Acabamento sobre parafuso (tampinhas).

Material virgem.

Bornes em latão maciço.

Montagem simples, rápida e eficiente.



Plafon BR 100W 250V~  
c/ Recept. Importado  
Econ.  
Branco: Cód. 180931  
Preto: Cód. 180831



Plafon Preto (com Borne)

Em Porcelana 100W 250V~: E. Econ.: Cód. 18081  
Em PP 100W 250V~: E. Econ.: Cód. 1808  
Em PP 60W 250V~: Cód. 1608  
Em PP 60W 250V~: E. Econ.: Cód. 16081



Plafon Branco (com Borne)

Em Porcelana 100W 250V~: E. Econ.: Cód. 18091  
Em PP 100W 250V~: BL: Cód. 1809B  
Em PP 100W 250V~: E. Econ.: Cód. 1809  
Em PP 60W 250V~: Cód. 1609  
Em PP 60W 250V~: E. Econ.: Cód. 16091



Plafon 2 Lâmpadas  
100W 250V~  
Branco: Cód. 18092  
Preto: Cód. 18082  
Exclusividade  
ILUMI 100W



Plafon Decor 100W 250V~  
Cód. 18095

parafusos banhados  
não enferrujam

O MELHOR E + VENDIDO DO BRASIL

# LUMINÁRIA TARTARUGA



Luminária Tartaruga Decor  
com capa branca 25w 250V~  
Cód. 16112

Luminária Tartaruga Decor  
sem capa branca 25w 250V~  
Cód. 16111



Luminária Tartaruga  
Preta 23W/25W 250V~  
Cód. 1611



Luminária Tartaruga  
Branca 23W/25W 250V~  
Cód. 16110

Potência máxima:  
25W / 250V~



Grau de proteção



IP 55  
• Testado conforme NBR IEC 60529  
• Proteção relativa contra poeira e contato a partes internas.  
• Proteção contra jatos de água.  
• Indicado para uso em jardins e ao tempo sem abrigo.  
• Não pode ser imerso em água.



Luminária Tartaruga Decor  
com capa preta 25w 250V~  
Cód. 16113



Podem ser usadas com lâmpadas de LED  
• Essas informações se enquadram somente nas luminárias Tartaruga.

Grau de proteção



IP 54  
• Testado conforme NBR IEC 60529  
• Proteção relativa contra poeira e contato a partes internas.  
• Protegido contra projeções de água.  
• Indicado para uso ao tempo, com abrigo.  
• Não pode ser imerso em água.





ACESSE O SITE

# eletrônica

## SENSORES DE PRESENÇA E RELÊS



Sensor de Presença de Sobrepor c/ Lente de 360° Teto com Articulador Bivolt Branco - Cód. 5603



Sensor de Presença de Sobrepor c/ Lente de 180° Parede com Articulador Bivolt Branco - Cód. 5606



Sensor de Presença para Área Externa Lente 180° Bivolt - Cód. 5604  
**área externa**



Sensor de Presença de Sobrepor com Lente de 360° Teto Bivolt - Cód. 5611

\*Lâmpada incandescente 127V~ 500W - 220V~ 1000W  
\*Lâmpada fluorescente 127V~160W - 220V~ 320W

Sobrepor e Embutir

\*Indicado o uso de 2 produtos em corredores longos.



Sensor de Presença de Embutir Bivolt Lente 180° - Cód. 5605



Sensor de Presença de Embutir Timer Bivolt Lente 180° - Cód. 5610



Relê Fotocélula QR50 com Base Bivolt + Timer NA - Cód. 5607  
Relê Fotocélula QR51 com Base Bivolt NF - Cód. 5609



Relê Fotocélula QR53 Eletrônico Bivolt - Tipo NA - Cód. 5608

## DIMMERS BIVOLT



Rotativo 127 / 220 V~ 127 / 150 V~ Branco: Cód. 5002 \*127V~ 150W 220V~ 300W



Controle de Ventilador Stylus 4x2 Com Acionamento de Lâmpadas e Inversão do Sentido da Rotação Bivolt: 127 / 220 V~ Branco: Cód. 5502 \*127V~ 150W 220V~ 300W

## CIGARRAS



Cigarras Cinza: Cód. 16900 Branca: Cód. 26900

## CONTROLES DE VENTILAÇÃO



Comercial Bivolt: 127 / 220 V~ Preto: Cód. 3302 Branco: Cód. 5302 \*127V~ 150W 220V~ 300W

## CAMPAINHA

O transmissor é homologado pela ANATEL



\*Não possui resistência à água



Campainha Musical a pilhas s/ Fio + Controle Remoto em Blister - 32 Toques Cód. 26930B  
\*Acompanha uma pilha 12V 23A.  
\*Pilhas AA não estão inclusas.



# EXTENSÕES COMPACTAS

TAMBÉM DISPONÍVEL EM BLISTER



Extensão Compacta Bipolar c/ Cordão Paralelo em Blister 10A 250V~

COR	3M	5M	10M
BRANCA	17911B	17921B	17931B
PRETA		17922B	



Paralelo 2x0,75

A MAIS VENDIDA DO BRASIL

3 Vias 3x0,75

Extensão Compacta c/ Cordão Paralelo 10A 250V~

Extensão Compacta 2P+T c/ Cabo PP Chato 10A 250V~

Extensão Compacta Bipolar c/ Cordão Paralelo 10A 250V~				
COR	1,5M	3M	5M	10M
CINZA	1790	1791	1792	1793
BRANCA	17901	17911	17921	17931
PRETA	17902	17912	17922	17932

Extensão Compacta 2P+T c/ Cabo PP Chato 10A 250V~				
COR	1,5M	3M	5M	10M
CINZA	1798	1799	17100	17200
BRANCA	17981	17991	171001	172001
PRETA	17982	17992	171002	172002

Extensão Compacta 2P+T c/ Cabo PP Chato em Blister 10A 250V~

COR	3M	5M	10M
CINZA		17100B	
BRANCA	17991B	171001B	172001B
PRETA		171002B	172002B

TAMBÉM DISPONÍVEL EM BLISTER



ACESSE O SITE

# flex

PLUGUES E TOMADAS CERTIFICADOS CONFORME NBR NM 60884-1 E NBR 14136 E CABOS CONFORME NBR NM 247-5

Cordão Prolongador 250V~ - Cinza  
3m - Cód. 16810  
5m - Cód. 16813  
10m - Cód. 16816



10A



10A

Cordão Prolongador 250V~ - Branco  
3m - Cód. 16811  
5m - Cód. 16814  
10m - Cód. 16817



10A

Cordão Prolongador 250V~ - Preto  
3m - Cód. 16812  
5m - Cód. 16815



TAMBÉM DISPONÍVEL EM BLISTER

Extensão em barra cabo PP redondo 20A 250V~ - Branca  
1,5m - Cód. 1699951B

## extensões em barra cabo PP redondo 20A



20A

3 Vias 3x2,5

PLUGUES E TOMADAS CERTIFICADOS CONFORME NBR NM 60884-1 E NBR 14136 E CABOS CONFORME NBR NM 247-5

3 Vias 3x2,5 2P+T 20A 250V~ Cabo PP Redondo

COR	1,5M	3M	5M
BRANCA	1699951	169997	1699970
PRETA	1699952	169998	1699980

# EXTENSÕES ENROLÁVEIS

Pode ser utilizado parcialmente desenrolado.



Extensão Enrolável Cordão Paralelo 2P Branca - 5m  
Preta - 5m

127V~  
250V~



COR	EMB. ECONOM.	BLISTER
BRANCA	16973	1697
PRETA	16974	16970

## LANÇAMENTO · EXTENSÕES PLAY · LANÇAMENTO · EXTENSÕES PLAY ·

NA MEDIDA CERTA



Paralelo 2x0,75

3 Vias 3x0,75

Extensão Econômica c/ Cordão Paralelo - Extensão Econômica 2P+T Cabo PP Chato - 250V

MEDIDA	10A - 2P			10A - 2P+T		
	CINZA	BRANCA	PRETO	CINZA	BRANCA	PRETO
2,5m	1783	17831	17832	1787	17871	17872
4,5m	1784	17841	17842	1788	17881	17882
8,0m	1785	17851	17852	1789	17891	17892

# TOMADAS EM BARRA



2P 10A

2P+T 10A

2P+T 10A

2P+T 20A

Tomada em Barra Quadrupla	
10A - 2P	
EMBALAGEM	CINZA BRANCA
INDIVIDUAL	1634 2634
PACOTE	1634PCT 2634PCT

Tomada em Barra Tripla 2P+T	
10A 20A	
EMBALAGEM	CINZA BRANCA CINZA BRANCA
INDIVIDUAL	16330 26330 16331 26331
PACOTE	16330PCT 26330PCT 16331PCT 26331PCT



2P 10A

Tomada em Barra Tripla Bipolar 2P	
10A	
EMBALAGEM	CINZA BRANCA
INDIVIDUAL	1633 2633
PACOTE	1633PCT 2633PCT



2P 10A

Tomada barra dupla 250V~ - Cinza 2P 10A Cód. 1632



# FILTRO DE LINHA PROFISSIONAL



## Informações Técnicas

Filtro de Linha e protetor de rede profissional  
Supressor de rede e ruídos  
Filtra ruídos aumentando o desempenho do produto.

Placa Circuito Eletrônico  
Evita curto-circuito e aumenta a vida útil do produto.

Gromet  
Evita quebra do cabo.

Prensa de cabo exclusivo.

127V - 1270VA  
220V - 2200VA



Com microdisjuntor bivolt, que substitui os fusíveis 6A e 10A

4 e 5 tomadas

Leds indicadores de tensão 127V~ou 220V~

ÚNICO COM 5 ANOS DE GARANTIA (Média Mercado: 6 meses)

\*Não é um estabilizador de voltagem.



Filtro de Linha com 5 tomadas c/ Cabo PP Chato de 1,0m 250 V~ - Branco  
Cód: 34012



Filtro de Linha com 4 Tomadas c/ Cabo PP Chato de 1,0m 250 V~ - Branco  
Cód: 34002



Filtro de Linha com 5 Tomadas c/ Cabo PP Chato de 1,0m 250 V~ - Preto  
Cód: 34014



Filtro de Linha com 4 Tomadas c/ Cabo PP Chato de 1,0m 250 V~ - Preto  
Cód: 34013



### Filtro de Linha Profissional

	4 Tomadas		5 Tomadas	
COR	EMB. ECONOM.	BLISTER	EMB. ECONOM.	BLISTER
BRANCO	34002	34001	34012	34011
PRETO	34013	34003	34014	34004



# FILTRO DE LINHA ECONÔMICO



Filtro de Linha econômico com 5 tomadas - Branco  
1,0m 250 V~ Cód: 34016

TOMADAS NA DIAGONAL.



Com microdisjuntor bivolt, que substitui os fusíveis 6A e 10A

\*Não é um estabilizador de voltagem.



Filtro de Linha econômico com 5 tomadas - Preto 250 V~ Cód: 34017

Cabo 1m

# FILTRO DE LINHA COM FUSÍVEL



Filtro de Linha com 5 tomadas com fusível - Branco  
1,0m 250 V~ Cód: 34019

TOMADAS NA DIAGONAL.



Filtro de Linha com 5 tomadas com fusível - Preto  
1,0m 250 V~ Cód: 34018





ACESSE O SITE

# marketing



Expositor Pequeno (p/ balcão)  
Cód. 04070001



Expositor de Canaletas  
Cód. 04070014

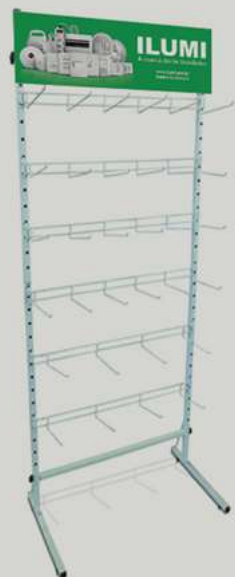

Expositor Aramado Desmontável de Chão  
Cód. 04070013



Expositor DPX Max  
Cód. 04070019

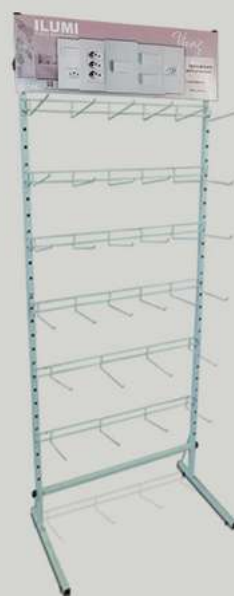

Expositor Aramado Vivaz Desmontável de Chão  
Cód. 04070024



Expositor Vivaz  
Cód. 04070025

Adesivo Testeira  
ILUMI  
Cód. A08

Stopper Institucional  
ILUMI  
Cód. 9999111

Dip Institucional  
ILUMI  
Cód. DIP003

Papel Forração 50m  
Cód. 9999102

Fita Porta Etiqueta  
Cód. 9999104

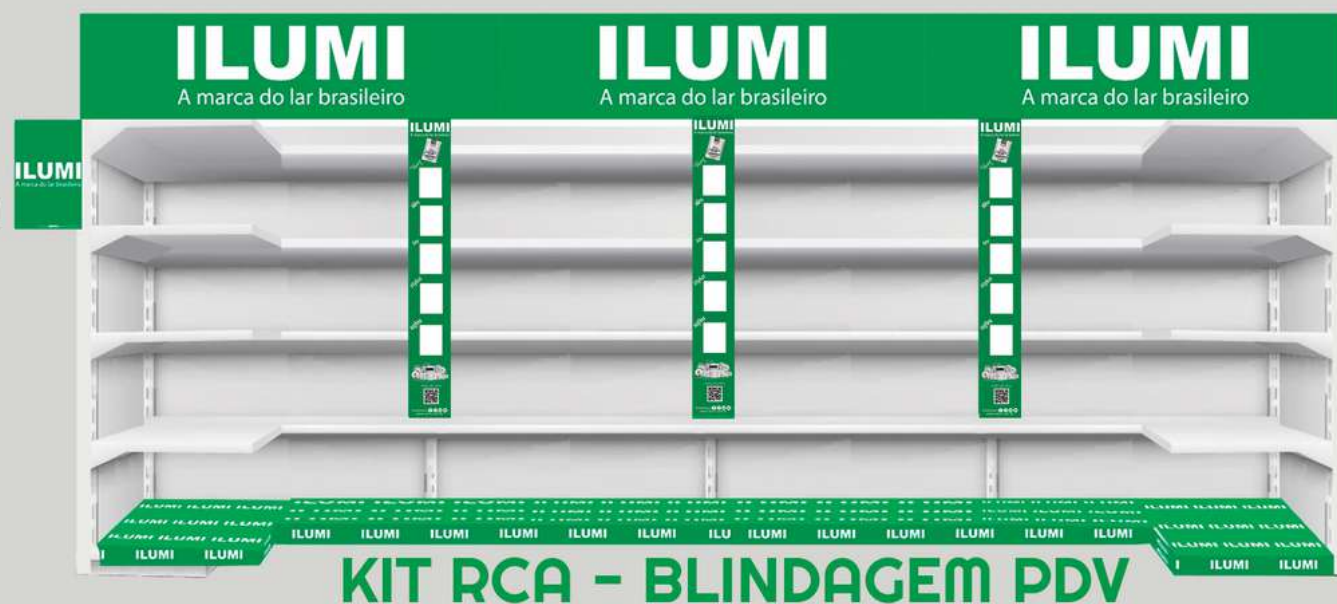

MOUSE PAD ILUMI  
Cód. 9999010



BOLINHA ANTI STRESS  
Cód. 9999011



CANETA ILUMI  
Cód. 9999024



LÁPIS ILUMI  
Cód. 9999022



RÉGUA ILUMI  
Cód. 9999023



FOLDER MIX ILUMI  
Cód. 9999062



COPO FUME ILUMI  
Cód. 99990592



BLOCO ANOTAÇÕES ILUMI  
Cód. 9999063



BLOCO MOLESKINE  
Cód. 99990631



CHAVEIRO E ABRIDOR  
Cód. 9999066



CESTO PRODUTOS  
Cód. 9999067



PAPEL FORRAÇÃO  
Cód. 9999102



SACOLA LOGO ILUMI  
Cód. 9999107



COOLER ILUMI  
Cód. 9999118



BEXIGA ILUMI  
Cód. BX01



DISPLAY DE BALCÃO VIVAZ  
Cód. DIP025



DISPLAY DE BALCÃO SLIM  
Cód. DIP015



DISPLAY DE BALCÃO LEV PRETA  
Cód. DIP028



DISPLAY DE BALCÃO LEV BRANCA  
Cód. DIP022



DISPLAY DE BALCÃO STYLUS  
Cód. DIP019



CACHAÇA ILUMI  
Cód. 9999108



CORDÃO PERSON.  
Cód. 9999077



MOBILE DE TETO  
Cód. 9999123



# ILUMI *Faz* + FEIRAS E EVENTOS

## + FEIRAS E CONVENÇÃO

- FEICON 2023
- CONSTRUSUL 2023
- EXPOCONSTRUIR 2023
- 16º CONVENÇÃO NACIONAL DE VENDAS



FEICON 2023



CONSTRUSUL 2023



EXPOCONSTRUIR 2023



16º CONVENÇÃO NACIONAL DE VENDAS

## + EVENTOS

- + de 40.000 pessoas impactadas em 2023
- + de 3.000 pessoas treinadas em 2023
- + de 370 eventos espalhados pelo Brasil em 2023



# PRODUÇÃO DA ILUMI AGORA TEM QUALIDADE ISO 9001-2015



ISO 9001:2015  
Válido até:  
2026-11-16

www.tuv.com  
ID 9000030509



Desde dezembro de 2023 a ILUMI tem a qualidade de seus processos atestada pelo Certificado ISO9001-2015. A certificação ISO 9001 é um padrão internacional que estabelece os requisitos para um sistema de gestão de qualidade eficaz em uma organização. Este padrão é emitido pela International Organization for Standardization (ISO) e reconhecida em todo o mundo como uma referência para garantir a qualidade dos produtos e serviços oferecidos pelas empresas.



REUNIÃO DE APROVAÇÃO DO ISO



REUNIÃO DE APROVAÇÃO DO ISO

# ILUMI *Faz* + UnILUMI

UNIVERSIDADE CORPORATIVA

A UnILUMI ( Universidade corporativa da ILUMI) foi idealizada em 2019 com o intuito de levar + conhecimento para os nossos colaboradores. São feitos encontros de 40 minutos ministrados por parceiros ou profissionais renomados do mercado. Desde 2019 já realizamos 62 encontros da UnILUMI até março de 2024. E continuaremos levando conhecimento e experiências tanto para os nossos colaboradores quanto para os nossos parceiros.



ACESSE O SITE

## ILUMI - ESG



PROJETO SOCIAL  
MENINOS DA VILA LEME-SP



PEQUENOS GRANDES LEITORES



VIR À VIDA NO TATAME - DESDE 2014



ESCOLA DE ATLETISMO &  
PARKOUR ANOS 3 E 4



SERVIÇO DE ACOLHIMENTO INSTITUCIONAL,  
NA MODALIDADE ABRIGO INSTITUCIONAL -  
CASA DO VOVÓ



PROJETO CUIDAR -  
HOSPITAL DE AMOR



